



ZEISS O-SELECT
Digital Measuring Projector



We make it visible.



//O-SELECT
MADE BY ZEISS

A black and white photograph of a laboratory setting. In the foreground, a microscope is positioned on a desk. A tablet computer is placed on the microscope's stage, and a hand is visible on the left side, holding the tablet. To the right of the microscope, a laptop is open, showing a bright screen. The background is slightly blurred, showing a wall with some faint markings or text. The overall scene suggests a modern, technology-integrated laboratory environment.

The moment you get total certainty
at the push of a button.

This is the moment we work for.

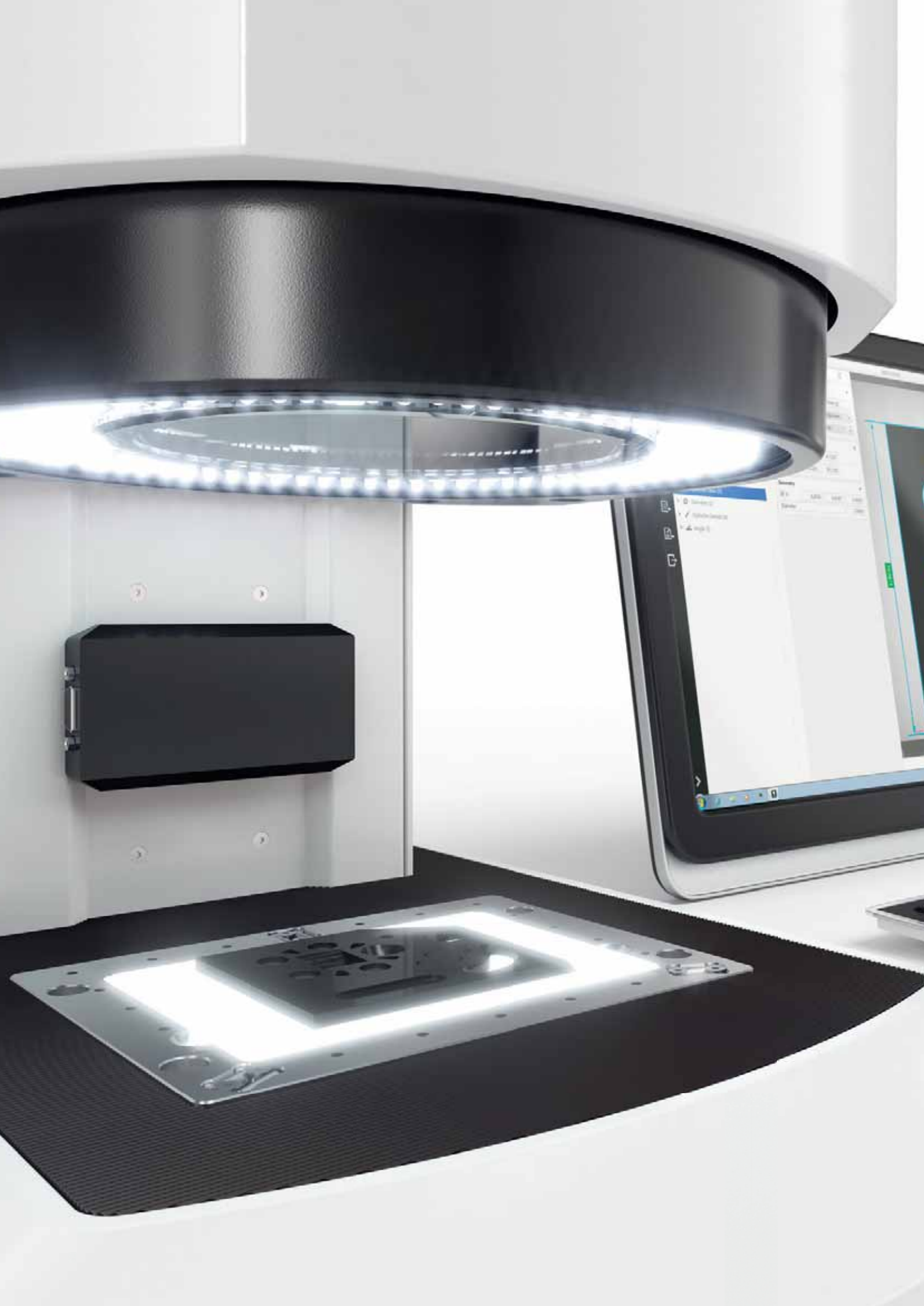

Reliably measure at the push of a button

ZEISS O-SELECT makes the optical measurement of 2D parts easy and reliable. Thanks to fully automatic setting of both illumination and focus, measuring errors due to operator influence are eliminated. With the simple push of a button, ZEISS O-SELECT evaluates the characteristics and documents the results – also in a professional report if needed.



Fully automated

- Position the part **1**
- Start the serial measurement **2**
- Reproducible, traceable results and automated report output ●

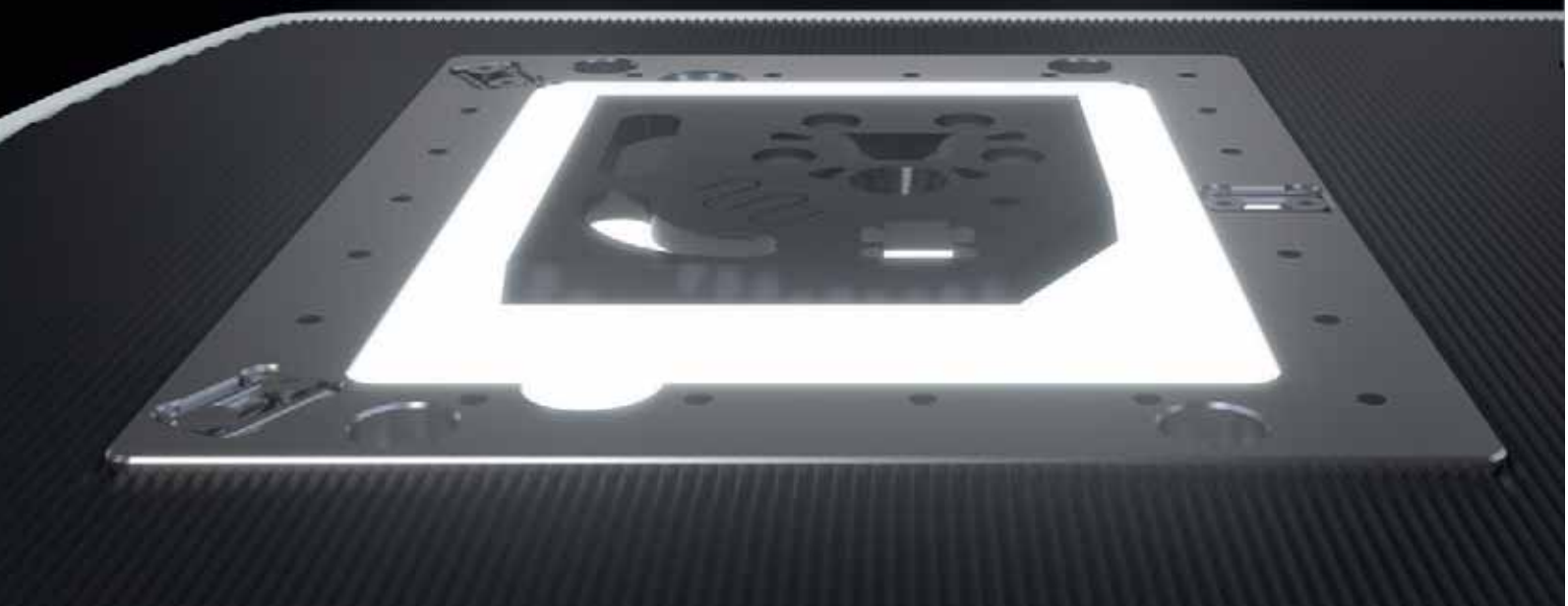

Fields of application

Whether it is used in the automotive, electronic or plastic processing industries, ZEISS O-SELECT provides precisely the simplicity and reliability needed in today's industrial environment. The digital measuring projector is particularly suitable for checking the dimensional accuracy of distances, radii or angles. Common test parts include punched and formed parts, or injection-molded and laser-cut workpieces.

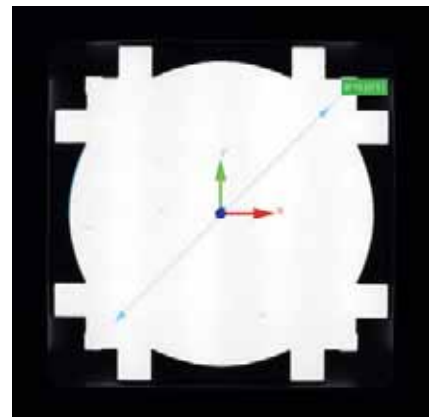
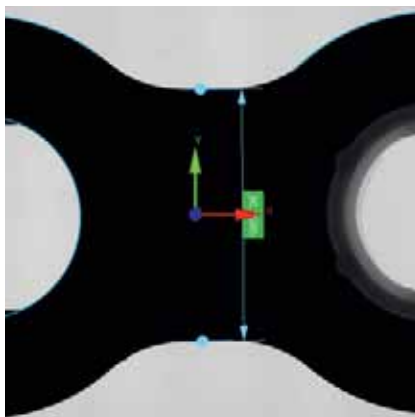
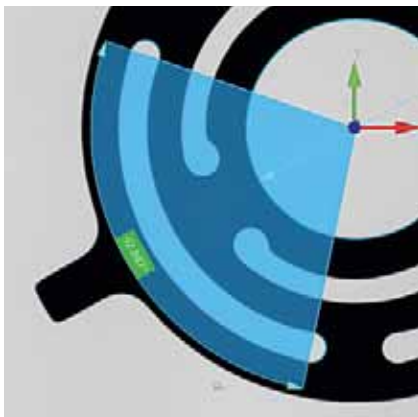

ZEISS O-SELECT measures characteristics like angles, distances and radii quickly and reliably.

Automatically focused

Manual focusing can often lead to errors – all unnoticed by the operator. The result: measuring errors of up to several micrometers. To eliminate this source of error, ZEISS O-SELECT automatically identifies the characteristics to be tested and sets the focal plane accordingly. In other words, operator errors are eliminated.



Telecentric optics

Standard camera lenses are based on the central perspective principle: the farther away an object is, the smaller it is imaged on the sensor. A telecentric lens, on the other hand, does not change the image magnification when the object is moved axially. This means that the dimensional accuracy can be captured correctly, regardless of the distance to the object.

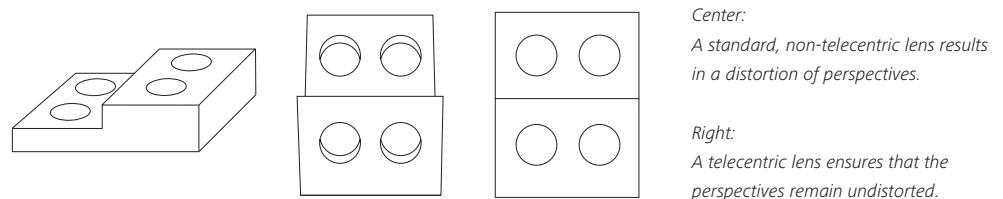



The centerpiece of the optical system is low-distortion, telecentric ZEISS optics with a high-resolution camera chip.

Automatically the best light

Optical measurement can only succeed if the illumination is right. To ensure that each characteristic is seen in the best possible light, ZEISS O-SELECT offers a variable illumination system. The illumination is set automatically to each characteristic, ruling out any possibility of operator error.

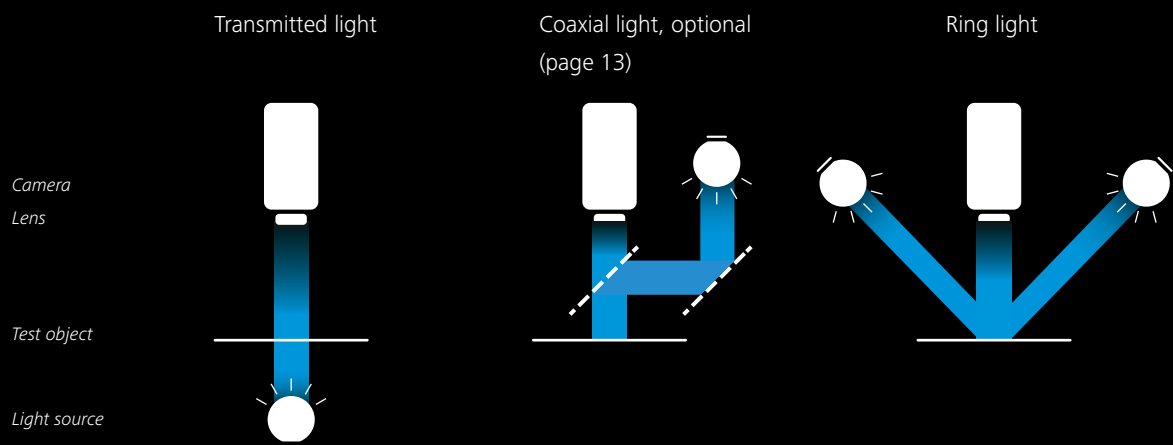

ZEISS O-SELECT automatically and individually adjusts the intensity of each of the eight segments of the double ring light – depending on the properties of the workpiece and the position of the characteristics





Eight-segment double ring light for variable reflected-light illumination

Mounting block for optional coaxial light

Transmitted light for maximum contrast



Intelligent, compact and reliable

The efficient system for 2D geometries

The hardware and software of ZEISS O-SELECT are optimally matched to ensure that 2D geometries can be tested with outstanding speed and reliability. Its compactness and robustness allow ZEISS O-SELECT to be installed at practically any location. You can measure your test parts precisely where you need to – whether in incoming inspection or in production.

System components

The system consists of the measuring system, the touch display keyboard and the ZEISS O-SELECT software. The external display offers clear benefits over a small, integrated display: a better overview, better orientation and more detail. Its touch function further simplifies the operation of the system. The software was specially developed for the ZEISS O-SELECT system and features a new, innovative approach. This is a major benefit not only for inexperienced operators, but also for experts whose workload will be lightened by the intelligent software.

Coaxial light as an option

Illumination coaxial to the optics is also available. This is recommended for measuring deep-lying structures which would otherwise be concealed by shadow.



Machine size	402 mm x 510 mm x 727 mm (W x D x H)
Size of measuring field	approx. 100 mm x 90 mm
System components	Digital measuring projector, workstation, monitor screen, ZEISS O-SELECT software

High-resolution camera

Drive for the autofocus

Telecentric ZEISS optics

Double ring light, each
with eight segments

Optional coaxial light

Transmitted light

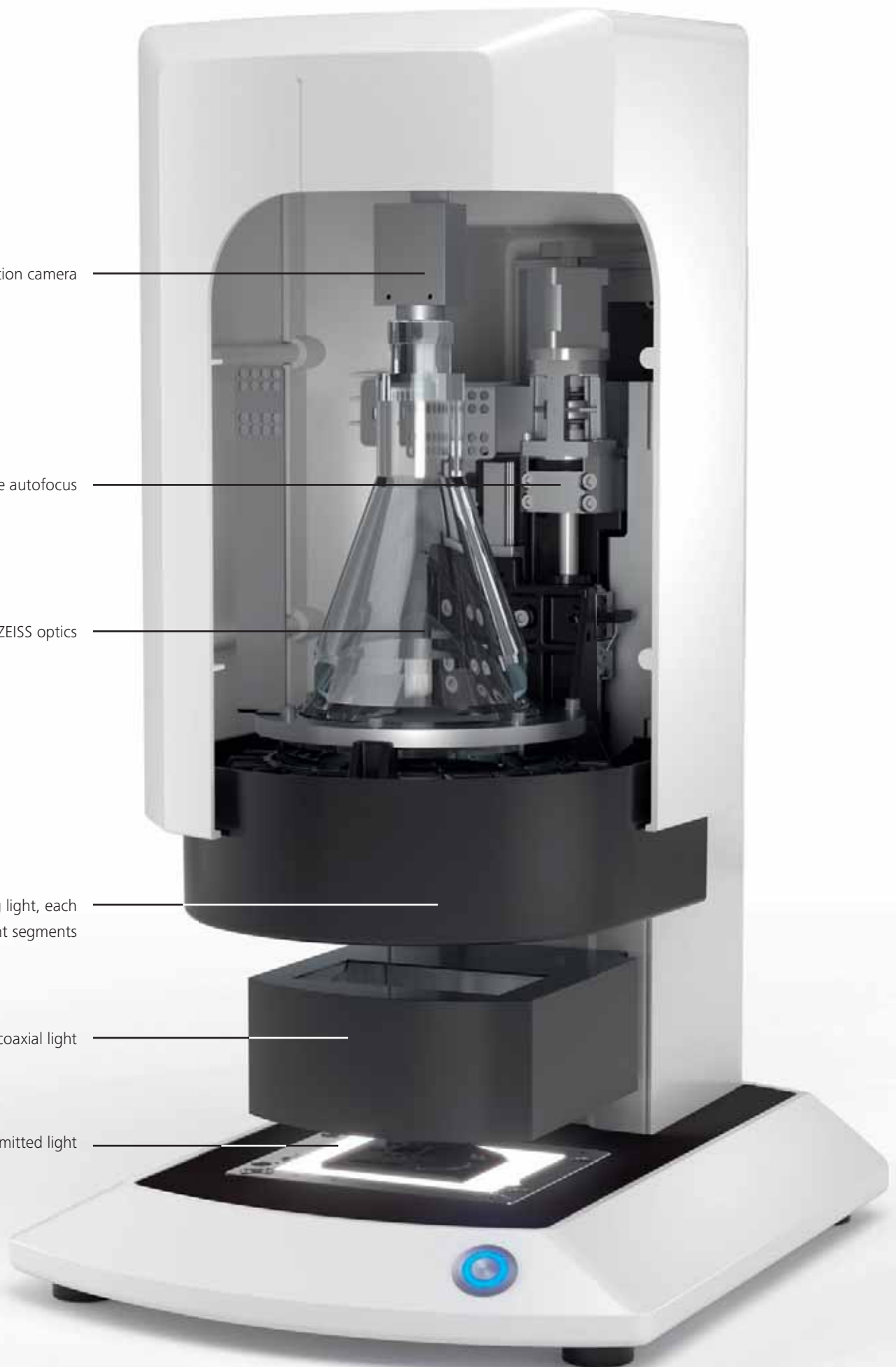

The fastest way to get your results

With the ZEISS O-SELECT software

The ZEISS O-SELECT software combines ZEISS metrology know-how with innovative, simple operation. Serial measurements are performed at the press of the button – regardless of the operator. Single measurements and measurement plans are no problem with ZEISS O-SELECT software: because it is so easy to understand, offers clear operator guidance and reduces workload.

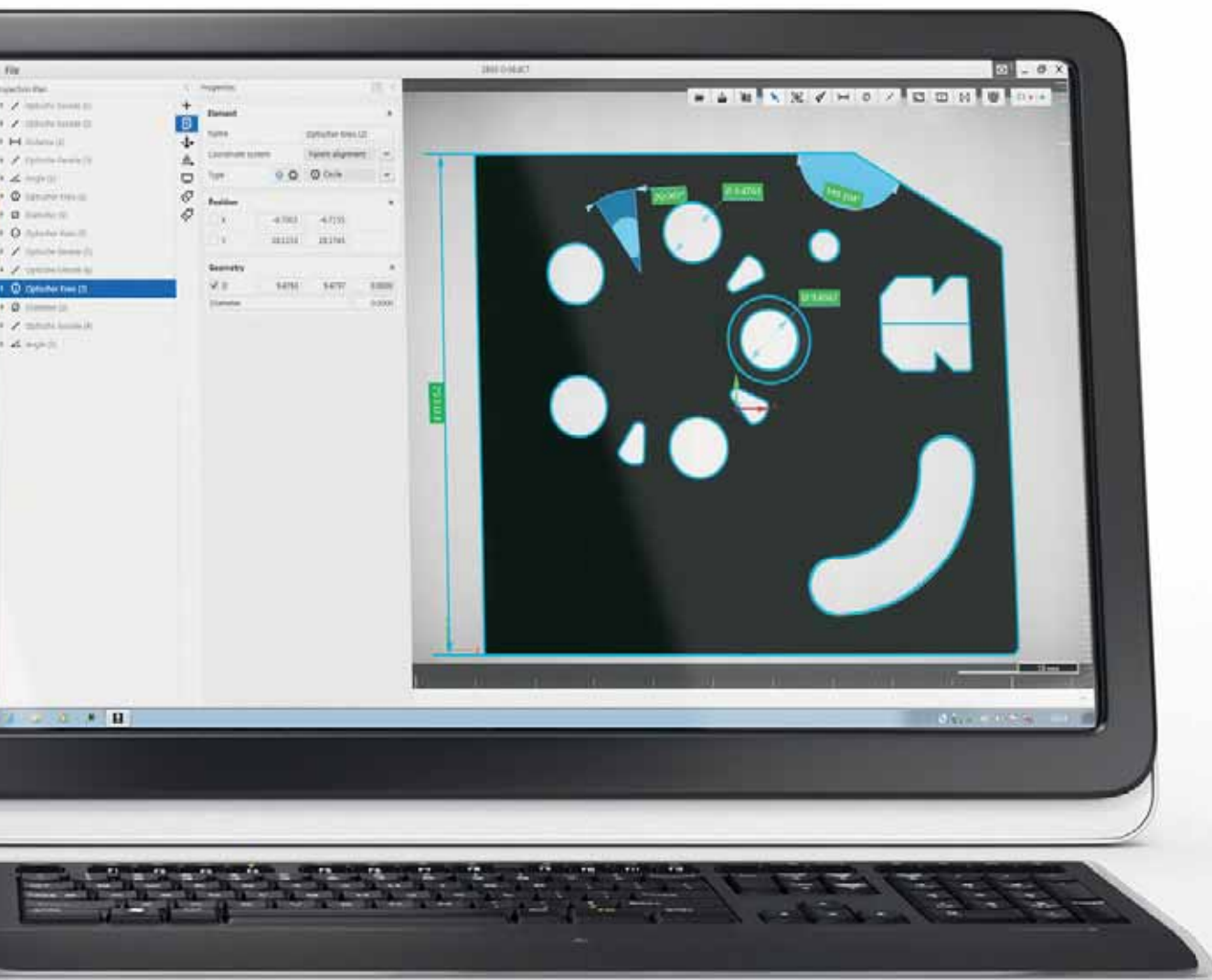

Controllable via touch display

Control ZEISS O-SELECT via a touch display and you will experience a new dimension in operator convenience. In many applications this means that the use of a keyboard and mouse is no longer needed.

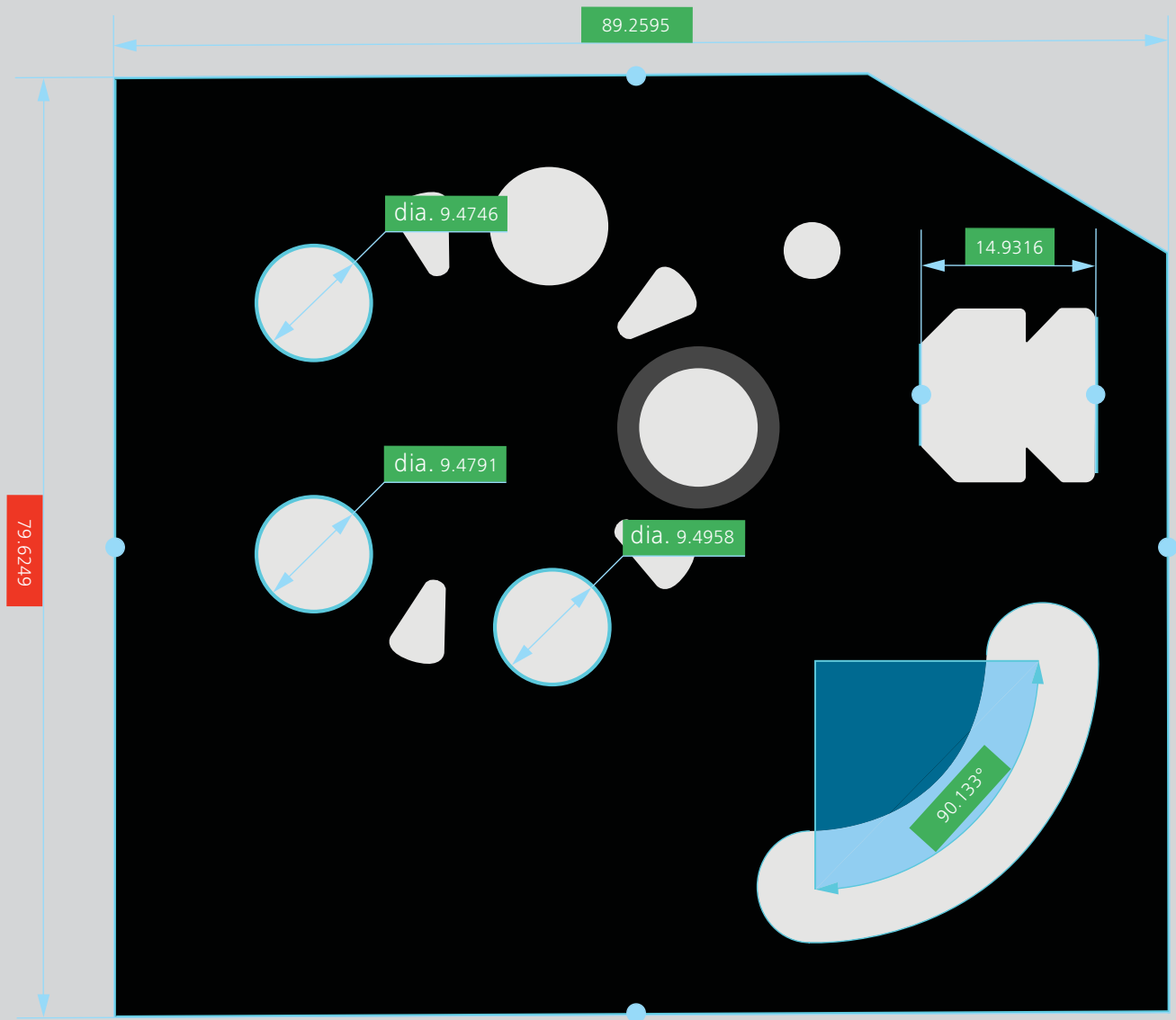

Results are projected beside the dimensioning arrows in the image.
The color code indicates immediately what values are within tolerance.

Measure directly in the image

The graphical user interface of ZEISS O-SELECT is a real innovation. As required functions and information are all just a mouse click away, measurement plans can be generated at unparalleled speed. You only see what you need. For most measurements, you will never have to leave the main window. Instead of navigating through sub-menus, you measure directly in the image.

Clear orientation

The intuitive user interface makes it easier for operators to navigate through the software. It shows clearly what point they have reached and guides them through the entire run: from creating a new project to the measurement plan and specifying the measuring run, users are guided throughout the entire process right up to the report.

Serial measurement at the press of a button

Parts for which a measuring plan has already been generated can be tested with ZEISS O-SELECT at the press of a button. The system identifies the positioned part and loads the appropriate program automatically. The alignment is also automatic. ZEISS O-SELECT sets the optimal illumination and focuses automatically. This not only lightens the operator's workload, but also makes the measurement operator-independent and reproducible. If required, the reliable result is automatically output or printed in a report.

Click & Pick: Click on the features on the right and the software will offer possible characteristics to choose from.

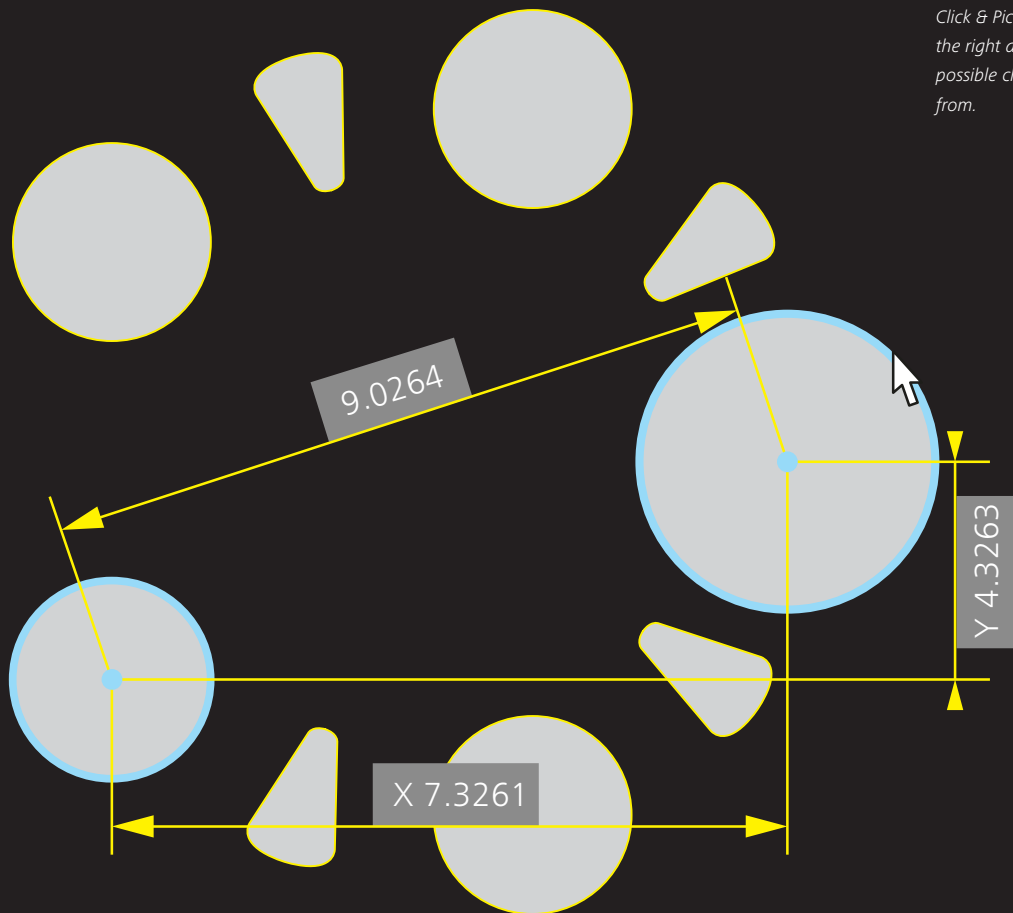

Single measurements the easy way – with Click & Pick

Even unknown parts for which no measurement plan has been generated can be measured quickly, easily and reliably with ZEISS O-SELECT. Using an automatically high-contrast and focused image, ZEISS O-SELECT identifies possible features like circles and straight lines.

When you move over one of these features with the mouse, you will receive possible characteristics such as radii, distances and angles. With a first **Click** you define an initial feature, and with a second **Pick** you select one of the suggested test features – all intuitively, directly on the object. The measured value then appears next to the dimensioning arrow. This way, you receive all desired dimensions of an unknown test part.

Generate measurement plans

It's just a small step from a single measurement to a serial measurement. You proceed in the same way as for a single measurement and select the required characteristics in the image using the Click & Pick function. No special knowledge is needed, as the programming is totally intuitive, and enjoyable too! During this, a measurement plan is already being generated in the background. All you have to do is save it – that's all there is to it.

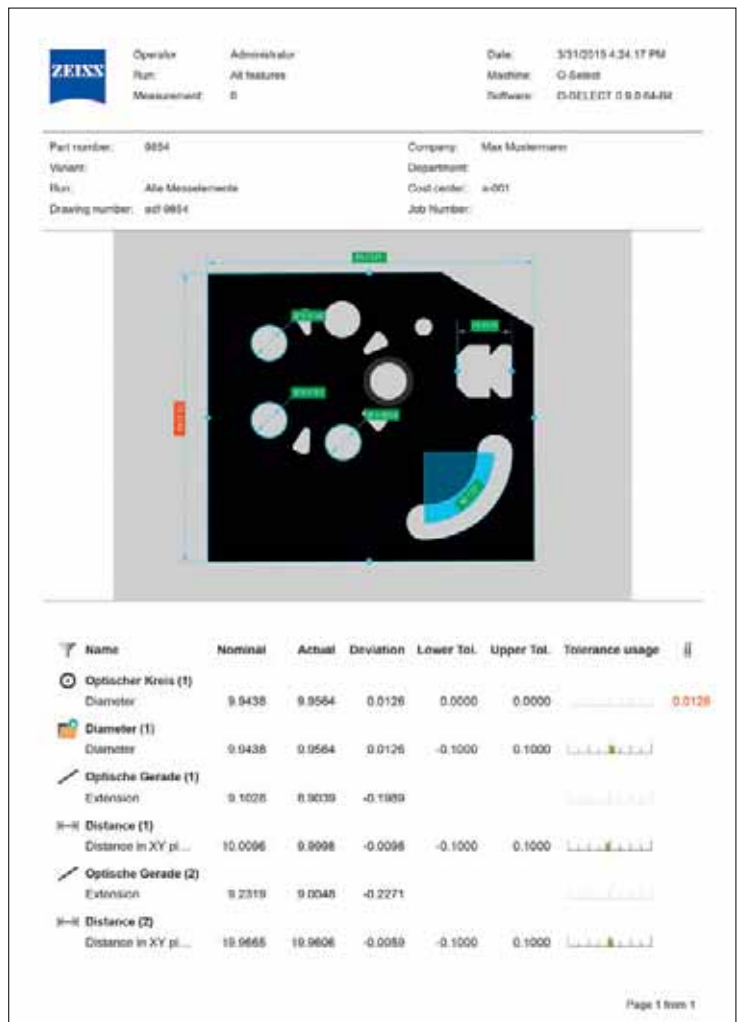

One example of a report – ZEISS O-SELECT also offers many other templates.

Single measurement and measurement plan generation

- Position the part **1**
- Start the single measurement **2**
- Select the characteristics with Click & Pick **3**
- Result and report **●**
- Save as a measurement plan **4**

Fully automatic serial measurement

- Position the part **1**
- Start the serial measurement **2**
- Result and report **●**

Professional reports

It's possible to record and evaluate the measurements with the reporting tool ZEISS PiWeb, integrated in the measurement software. For the efficient exchange of information, various report templates are available – from the straightforward graphic report to the detailed list report. This makes it possible to generate reports practically without effort and without any in-depth knowledge. One particularly simple possibility is the one-click report that outputs the current monitor view in a report at the push of a button. Templates with value displays in the image and form plots make it easier to understand the results. For the purpose of process inspection, templates with value flows and statistical parameters are also available. And if needed, you can also have a report of a specified format automatically displayed, saved or printed.

We make it visible

Optical inspection and measuring machines

ZEISS Industrial Metrology has set the quality standards and spearheaded innovation in the industry for almost 100 years. In the field of optics, ZEISS has set the pace for one and a half centuries. Optical machines from ZEISS combine all of this know-how and expertise. In other words, you receive optical inspection and measuring machines that will impress you in every respect – right from day one.



Optical testing and visualization

ZEISS Smartzoom 5

Sensors	optical (color camera)
Characteristics	Visualization and dimensioning of characteristics in the image

www.zeiss.com/smartzoom



Optical testing and measurement

ZEISS O-SELECT

Sensors	optical (grayscale camera)
Characteristics	Size, form and location in the image with subpixel accuracy, automatic part recognition; nominal/actual comparison using CAD data

www.zeiss.com/o-select



Optical and contact measurement

ZEISS O-INSPECT

Sensors	contact scanning and optical (grayscale camera)
Characteristics	Size, form and location in 3D, nominal/actual comparison using CAD data

www.zeiss.com/o-inspect



Experience ZEISS O-SELECT in action.

Experience how simple and reliable the optical measurement of 2D parts can be with O-SELECT, the optical measuring solution from ZEISS.

Register for a web demo now at:
www.zeiss.com/o-select

Carl Zeiss
Industrielle Messtechnik GmbH
73446 Oberkochen
Germany

Sales: +49 (0) 7364/ 20-6336
Service: +49 (0) 7364/ 20-6337
Fax: +49 (0) 7364/ 20-3870
Email: imt@zeiss.de
Internet: www.zeiss.com/imt